

Glass Passivated Bridge Rectifiers

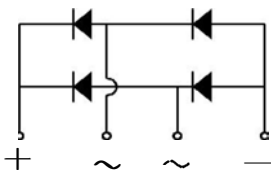
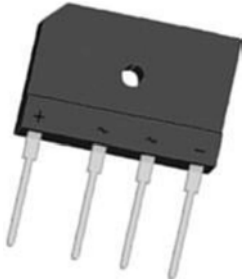

Features

- Reverse Voltage - 800 V
- Forward Current - 25.0 A
- Compliant With RoHS Provisions
- High Forward Surge Current Capability

Applications

- Case: GBJ
- Switching Power Supply
- Home Appliances, Office Devices
- Industrial Auto-equipments

Maximum Ratings and Electrical characteristics

Ratings at 25 °C ambient temperature unless otherwise specified.

Single phase half-wave 60 Hz, resistive or inductive load, for capacitive load current derate by 20 %.

Parameter	Symbols	GBJ2508	Units
Maximum Repetitive Peak Reverse Voltage	VRRM	800	V
Maximum RMS voltage	VRMS	560	V
Maximum DC Blocking Voltage	VDC	800	V
Average Rectified Output Current	I_o	25.0	A
Peak Forward Surge Current 8.3 ms Single Half Sine Wave Superimposed on Rated Load (JEDEC Method)	IFSM	330	A
$I^2 t$ rating for fusing (1ms < t < 8.3 ms)	$I^2 t$	452	A ² S
Maximum Forward Voltage at 12.5A	VF	1.05	V
Maximum DC Reverse Current @TA=25 °C at Rated DC Blocking Voltage @TA=125 °C	IR	5 500	μA
Typical Junction Capacitance (Note1)	Cj	70	pF
Typical Thermal Resistance (Note2)	R _{θJA} R _{θJC} R _{θJL}	10.0 2.0 1.5	°C/W
Operating and Storage Temperature Range	T _j , T _{stg}	-55 ~ +150	°C

Note: 1. Measured at 1MHz and applied reverse voltage of 4 VDC.

2. Unit Mounted on 100 x 100 x 1.6 mm Cu Plate Heatsink.

RATINGS AND CHARACTERISTICS CURVES (TA = 25 °C unless otherwise noted)

Fig. 1 - Forward Current Derating Curve

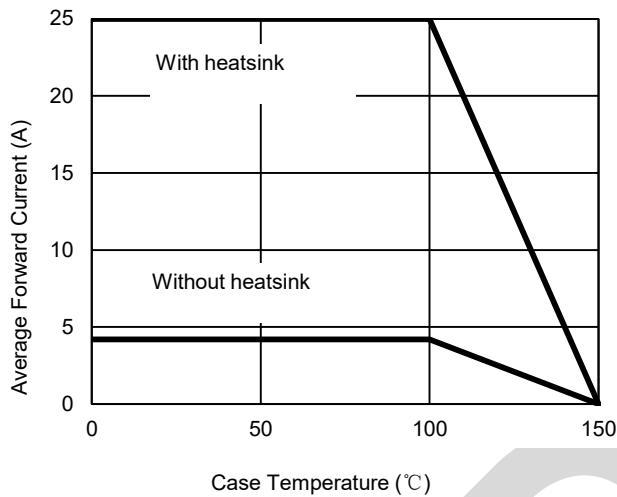

Fig. 2 - Maximum Non-Repetitive Surge Current

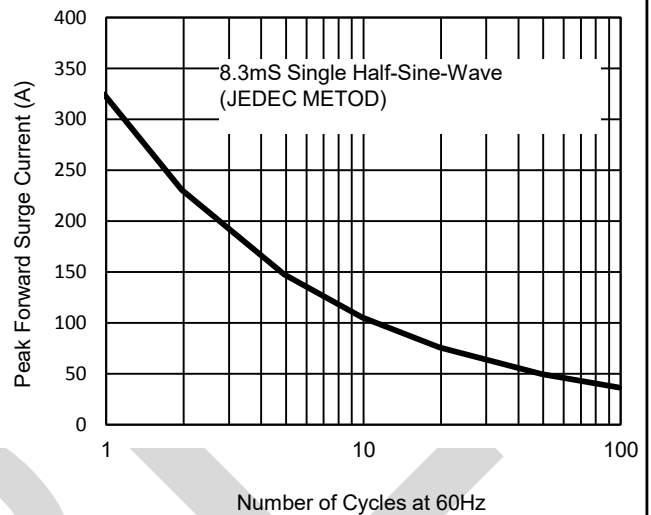

Fig. 3 - Typical Reverse Characteristics

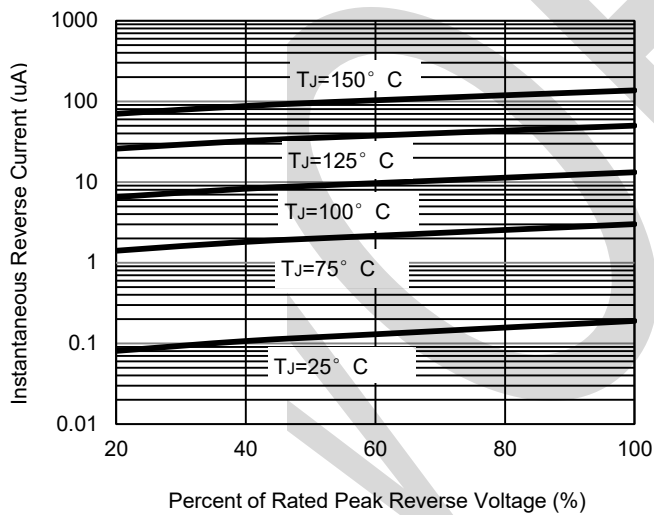
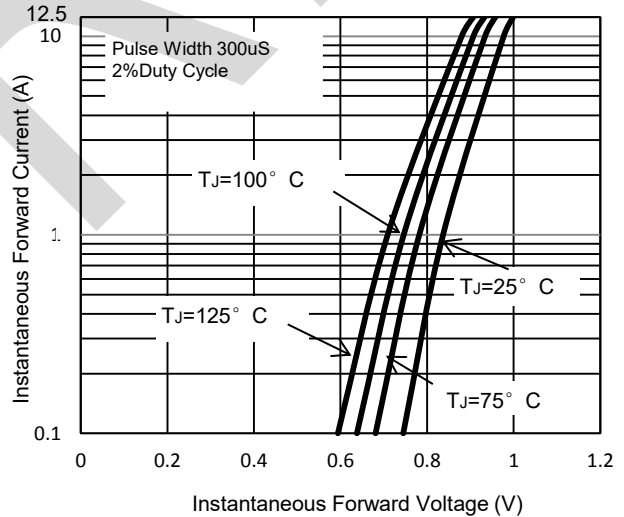
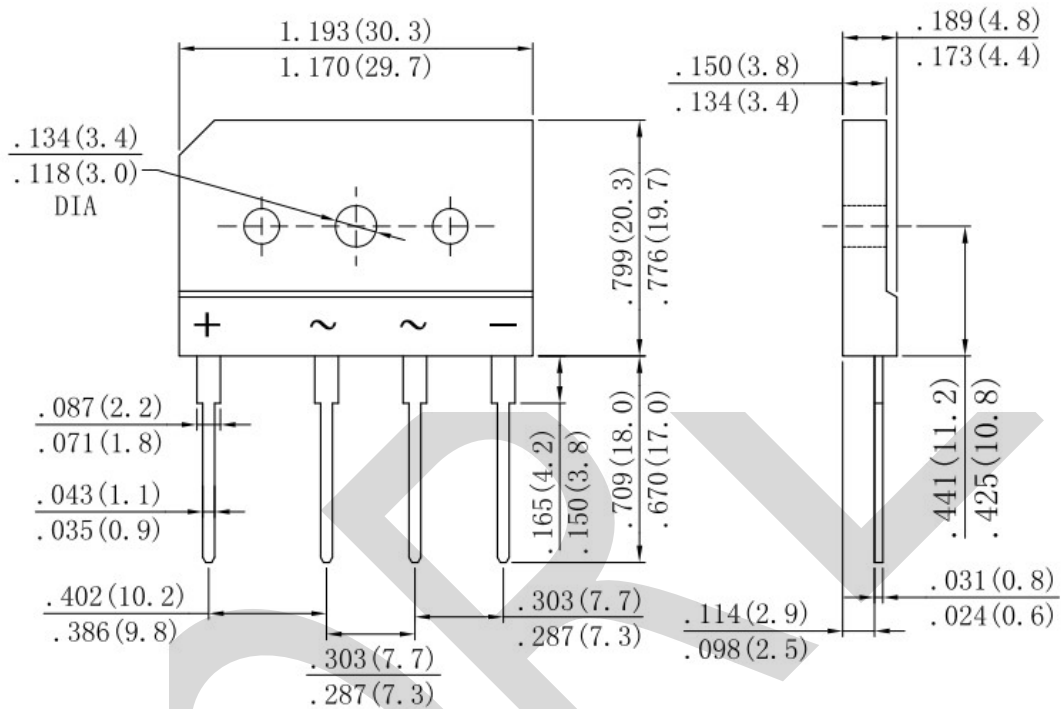

Fig. 4 - Typical Forward Characteristics



PACKAGE OUTLINE DIMENSIONS

Note:unit In(mm)



Dimensions in inches and(millimeters)